

8845-300 Quickstart Guide

Contents

In the box	01
What you'll need	02
Installation	03
Configuration	04
Testing	05
Regulatory	06
Support	07



01

In the box

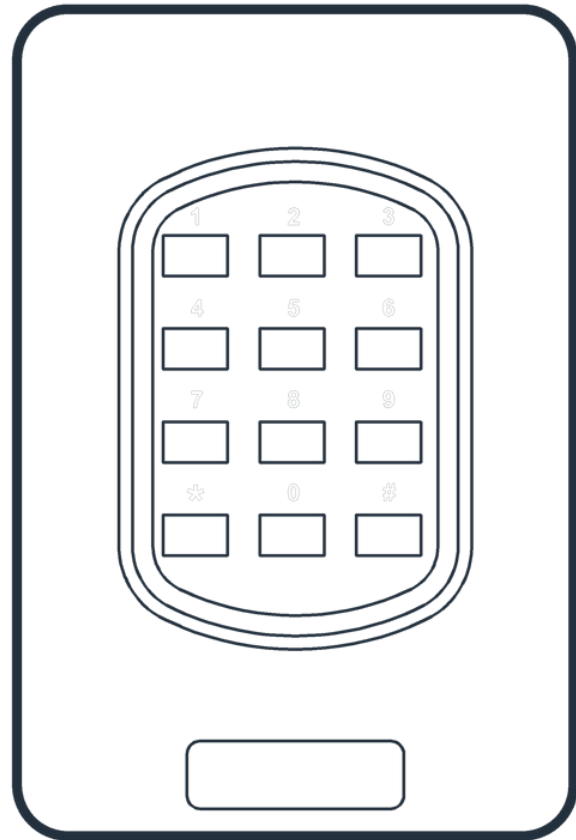

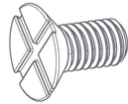

**#6-32 x .375" Phillips
flat head screw**

Secures the IoT Sensor and
the backplate together

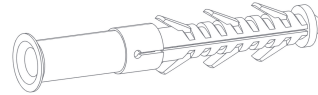

Nylon wall plugs

Used to brace the screws
inside the wall



**#6 x 1.5" Phillips
sheetmetal screws**

For mounting wall bracket



Mounting Plate

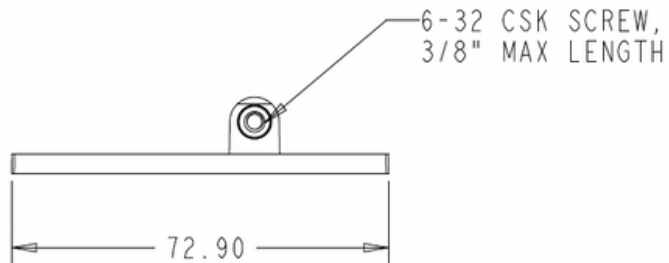
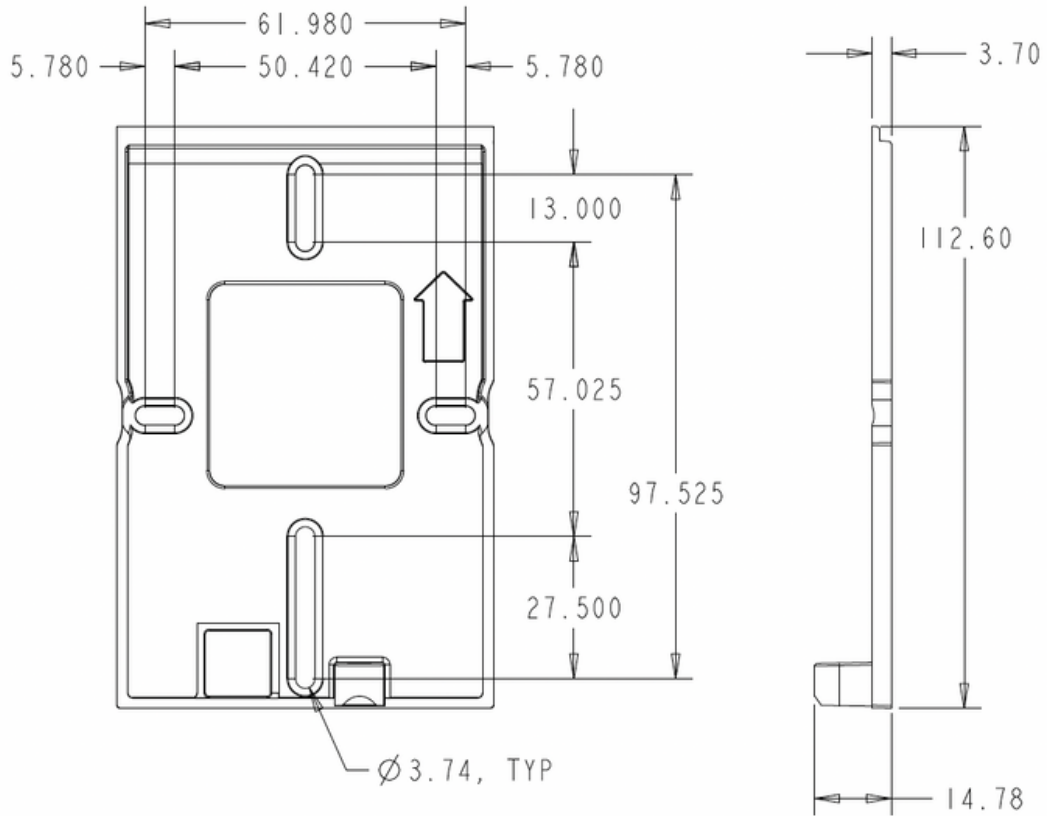

02

What you'll need



Cable Installation Note

Power requirements: 12 Volts DC +/- 5% and 250mA **at the endpoint** (IoT Sensor) is required.

We advise not only selection of the right gauge and power quality, but integrators should confirm the power delivery is sufficient by checking power at the endpoints.

If existing cable is of higher gauge / lower capacity and cannot be replaced, Safetrust sensors are designed to operate at up to 24VDC.*

As a result, higher voltage at the power source is safe to use with IoT Sensors if the source and wiring implementation can safely support it and if it is compliant with local code.

** Safetrust recommends against using the same 24V power supply for both locks and IoT Sensors.*



Power cable:

- 18/2 for distances < 500 ft.
- 16/2 for distances < 700 ft.
- For distances up to 1000', see Cable Installation Note above.

Data cable - Wiegand:

- Cable, 5-12 conductor, 4 conductor Twisted Pair Over-All Shield and UL approved (<500ft)

Data cable - OSDP:

- Belden 6381MD - 1Pr 24AWG Shielded Data + 18/2 Power OSDP CMP or equivalent (<500Ft)
- Belden 6281MD - 1Pr 22AWG Shielded Data + 16/2 Power OSDP CMP or equivalent (<700Ft)

Tools and Supplies:

- Metal or plastic junction box
- Drill with various bits for mounting hardware
- Additional tools and supplies as needed to connect sensor wires to associated system cable



03

Installation



Installation: Standard Wall Mount

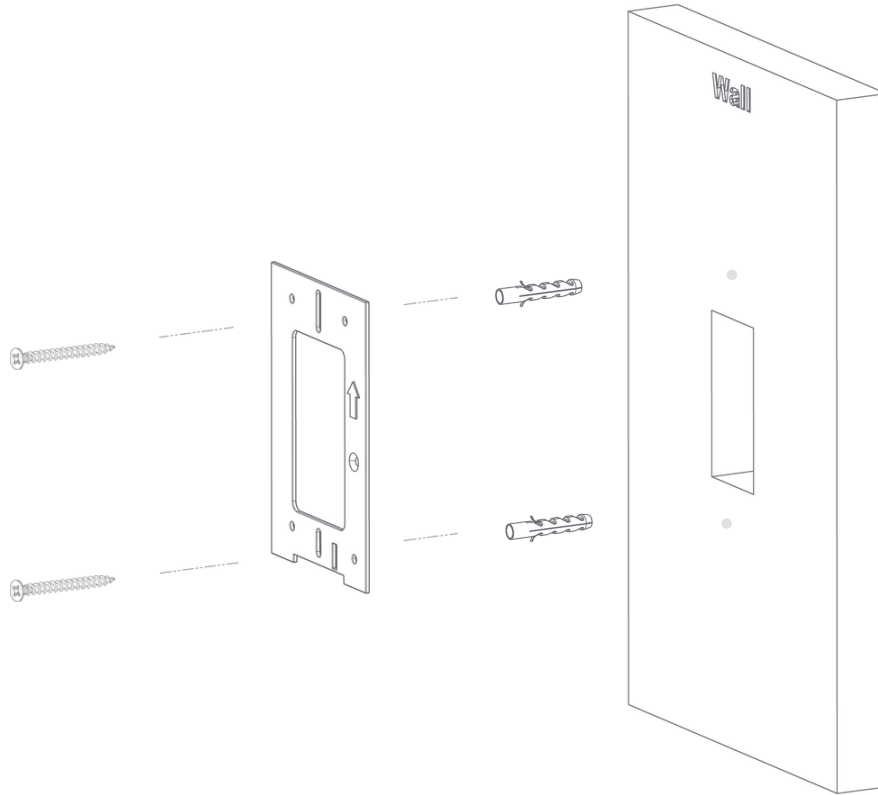

For a wall mounted installation, begin by pre-drilling your holes and insert the nylon wall plugs provided to support the weight of the reader. Once secured, you can fix the backplate to the wall using the Phillips sheetmetal screws (#6 x 1.5") provided.



Installation: Electrical Box

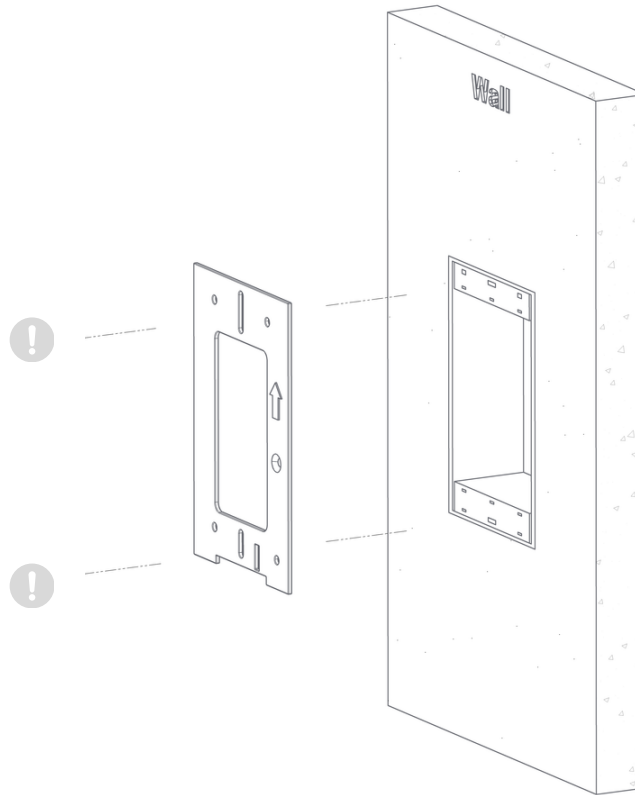

Locate the electrical box which will be recessed into the wall. You will see a top and bottom metal flange with holes which is used to secure the back plate to the wall. For this process you will need to use screws that are suitable for fixing to your specific electrical box (these are not supplied by Safetrust). Using the appropriate screws, fix the the backplate against electrical box so that it's flush.



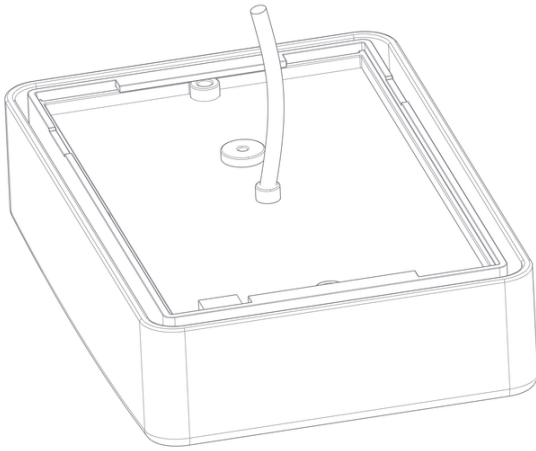

Wire Colors

Ground	●	Black
Relay In*	●	Grey
Relay Out*	●	Blue
Red LED	●	Brown
Tamper	●	Purple
Green LED	●	Orange
Wiegand D0/Data	●	Green
Wiegand D1/Clock/F2F	○	White
12VDC	●	Red
OSDP TX+ / RS-485(A) / D0	●	Aqua
OSDP TX- / RS-485(B) / D1	●	Pink
Beeper	●	Yellow

*Low voltage

The next step is to connect the wires as per the wiring table above.



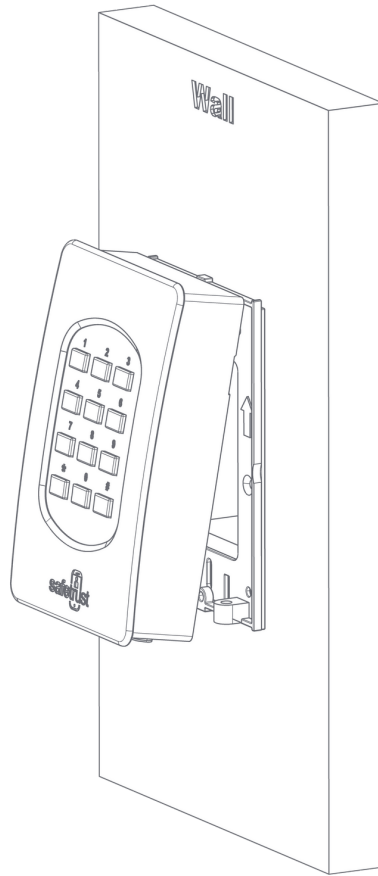

Once the backplate has been fitted and the wiring is complete, the IoT Sensor can be mounted to the wall as shown above.



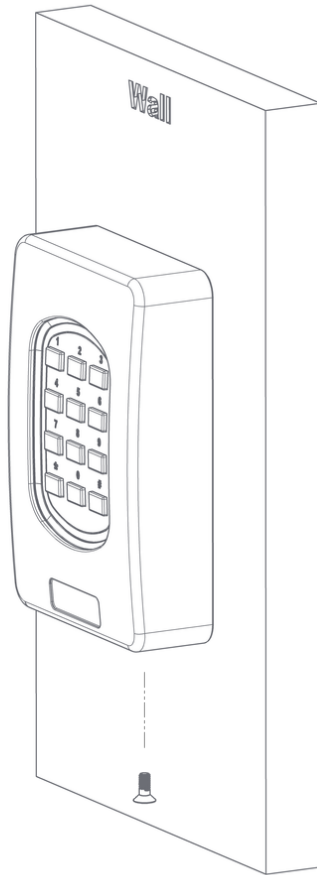

Complete the hardware installation by fixing the screw (#6-32 x .375" Phillips flat head screw) through the base of the reader.



04

Configuration



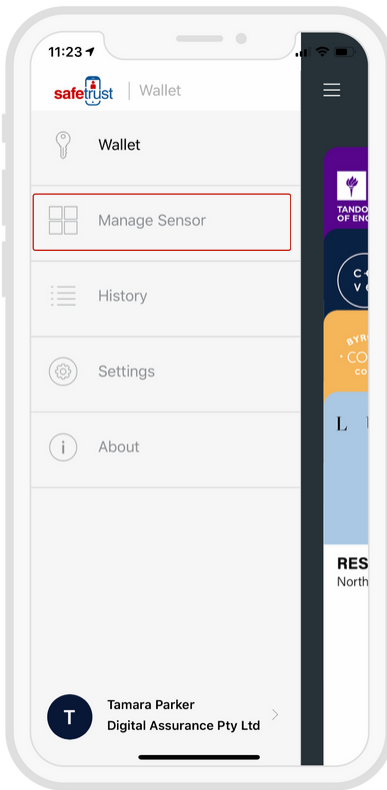

Open the Safetrust Wallet App and select the Manage Sensor tab from the navigation. Make sure your system administrator has set you up with a role that has rights to configure a sensor.



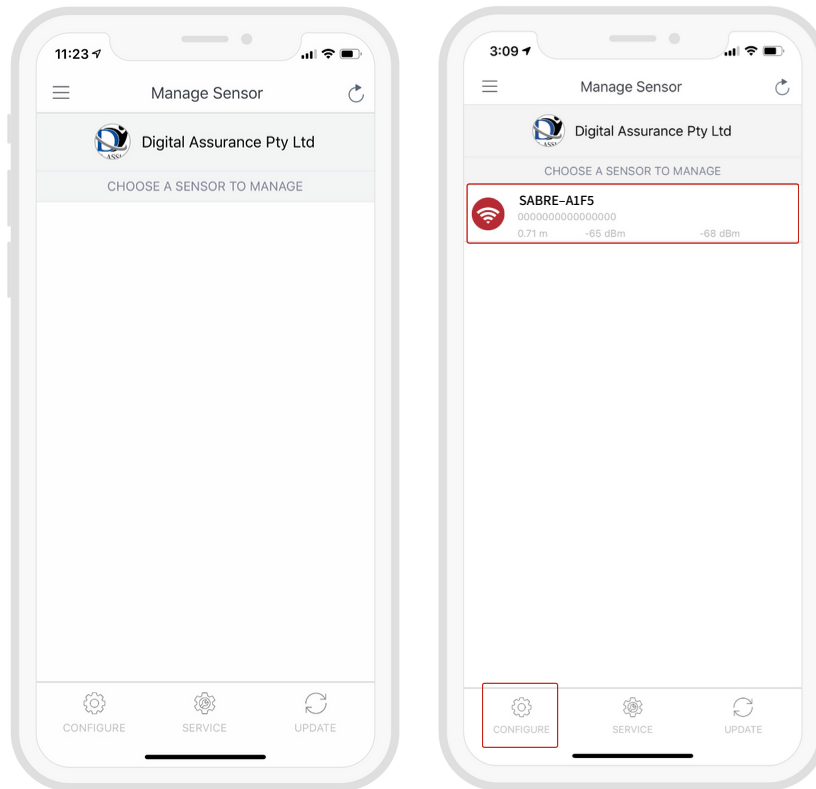

With the Manage Sensor tab open, bring the phone in range of the IoT Sensor and once visible from the App, highlight and select the “Configure” button.



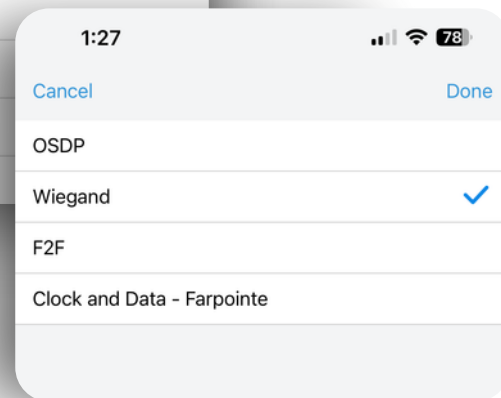
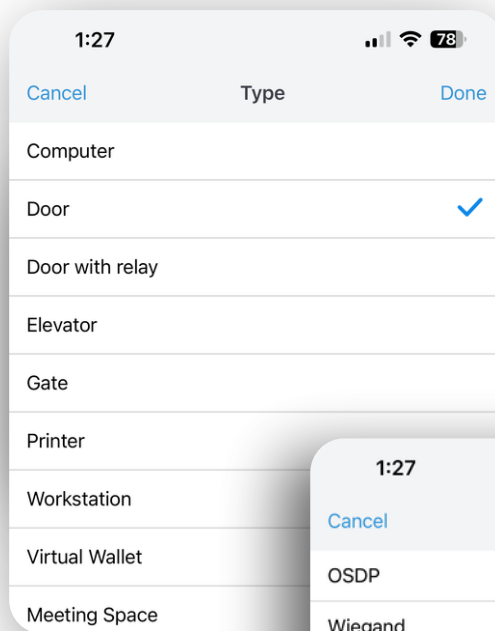
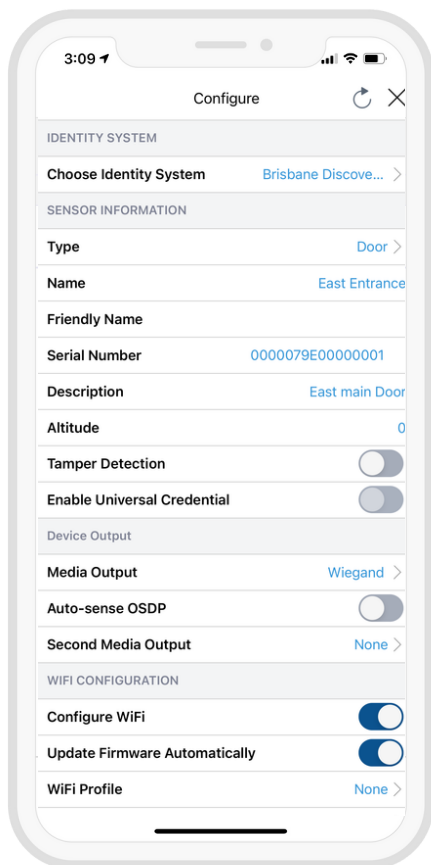

1. Choose an Identity System*.
2. Specify the Type of access from the dropdown (eg. Door, Gate etc.)
3. Assign a short Name and Description using alphanumeric characters.
4. Choose a Media Output for the sensor (the default is set to Wiegand).

**Note: Identity System must be previously created in the Safetrust Credential Manager portal by a system administrator.*



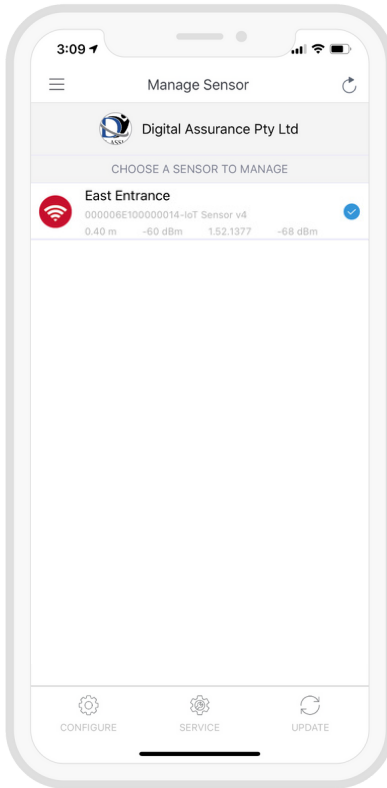

When the IoT Sensor information is saved successfully to Credential Manager and assigned to the Identity System, the new name will appear in the Manage Sensor tab with a unique serial number assigned.



05

Testing



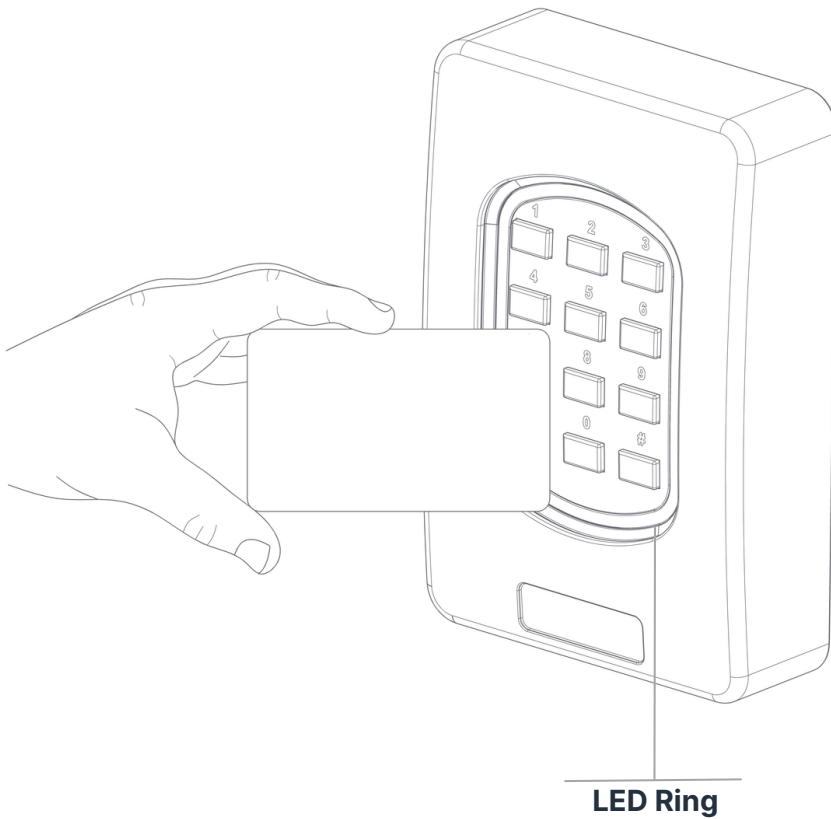

Access with cards

Status LED



Solid red
Indicates idle mode



Flashing red, blue, green
Power up mode



Flashing green
Card credential is read
and transmitted
through designated
wires



Access with Mobile – BLE

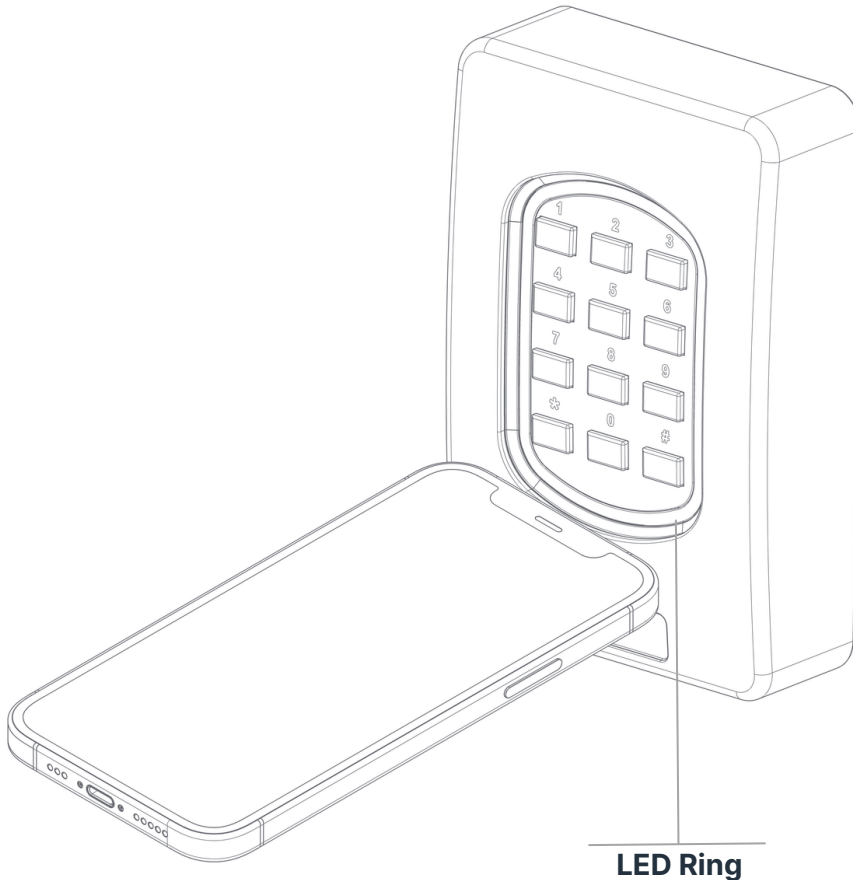

Status LED



Solid red
Indicates idle mode



Flashing red, blue, green
Power up mode



Solid Blue
Mobile credential
detected



Flashing green
Mobile BLE credential is
read and transmitted
through designated wires



Access with Mobile – NFC

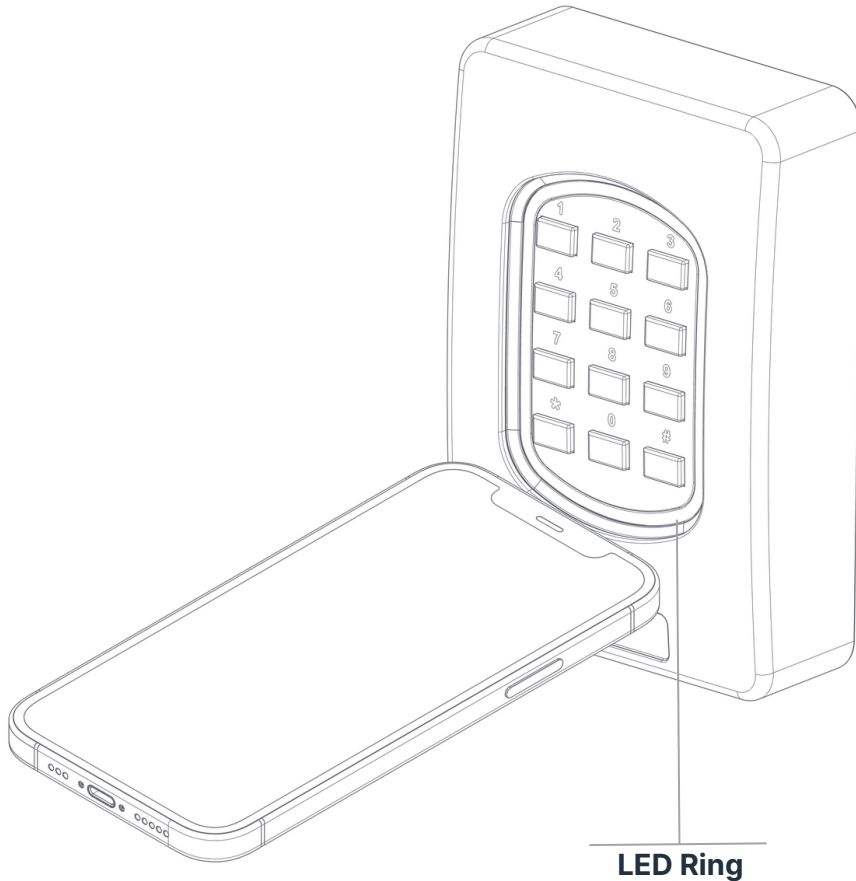

Status LED



Solid red

Indicates idle mode



Flashing red, blue, green

Power up mode



Flashing green

Mobile BLE credential is
read and transmitted
through designated wires



06

Regulatory Information



FCC: This device complies with part 15 of the FCC Rules. Operation is subject to the following two conditions: (1) This device may not cause harmful interference, and (2) this device must accept any interference received, including interference that may cause undesired operation.

Canada Radio Certification: This device complies with Industry Canada license-exempt RSS standard(s). Operation is subject to the following two conditions: (1) this device may not cause interference, and (2) this device must accept any interference, including interference that may cause undesired operation of the device.

Le présent appareil est conforme aux CNR d'Industrie Canada applicables aux appareils radio exempts de licence. L'exploitation est autorisée aux deux conditions suivantes : (1) l'appareil ne doit pas produire de brouillage, et (2) l'utilisateur de l'appareil doit accepter tout brouillage radioélectrique subi, même si le brouillage est susceptible d'en compromettre le fonctionnement.

CE Marking: Safetrust hereby declares that these proximity readers are in compliance with the essential requirements and other relevant provisions of Directive 1999/5/EC.



07

Support

Thank you for purchasing the Safetrust IoT Sensor Keypad.

If for any reason you need assistance with your installation, please contact your local Sales representative .

Sincerely -
The Safetrust Team



www.safetrust.com/support